

Pressure and temperature transmitters

ATM/T - Pressure and Temperature Transmitter



CUSTOMER BENEFITS

- Demountable electrical connector option allow adjustment of zero and span setting
- Fast customization thanks to modular product design
- Short response time suitable for dynamic pressure measurements

Technical Specifications

PRESSURE MEASURING RANGE (BAR)

	0.1 ... 0.5, (1)	> 0.5 ... 2	> 2 ... 25
Overpressure	3 bar	3 x FS (≥ 3 bar)	3 x FS
Burst pressure, (5)	≥ 30 bar	≥ 30 bar	3 x FS (≥ 25 bar)
Accuracy, (6), (\pm % FS)	$\leq 0.5 / \leq 0.25$	$\leq 0.5 / \leq 0.25 / \leq 0.1$	$\leq 0.5 / \leq 0.25 / \leq 0.1$
Thermal shift, (\pm % FS/ $^{\circ}$ C)			
Zero point 0 ... 70 $^{\circ}$ C	≤ 0.06	≤ 0.03	≤ 0.015
Zero point -25 ... 85 $^{\circ}$ C	≤ 0.08	≤ 0.04	≤ 0.02
Span 0 ... 70 $^{\circ}$ C	≤ 0.015	≤ 0.015	≤ 0.015
Span -25 ... 85 $^{\circ}$ C	≤ 0.02	≤ 0.02	≤ 0.02
Response time, (typ.)	< 1ms / 10 ... 90% FS	< 1ms / 10 ... 90% FS	< 1ms / 10 ... 90% FS
Long term stability, (7)	< 0.5% FS / < 4 mbar	< 0.2% FS / < 4 mbar	< 0.1% FS / < 0.2% FS

	> 25 ... 600, (2), (4)	> 600 ... 1000, (2), (3)
Overpressure	3 x FS ($\leq 850 / \leq 1500$ bar)	1500 bar
Burst pressure, (5)	> 850 / ≤ 1500 bar	> 1500 bar
Accuracy, (6), (\pm % FS)	$\leq 0.5 / \leq 0.25 / \leq 0.1$	$\leq 1 / \leq 0.5 / \leq 0.25$
Thermal shift, (\pm % FS/ $^{\circ}$ C)		
Zero point 0 ... 70 $^{\circ}$ C	≤ 0.015	≤ 0.015
Zero point -25 ... 85 $^{\circ}$ C	≤ 0.02	≤ 0.02
Span 0 ... 70 $^{\circ}$ C	≤ 0.015	≤ 0.015
Span -25 ... 85 $^{\circ}$ C	≤ 0.02	≤ 0.02
Response time, (typ.)	< 1ms / 10 ... 90% FS	< 1ms / 10 ... 90% FS
Long term stability, (7)	< 0.1% FS / < 0.2% FS	< 0.1% FS / < 0.2% FS

(1) 50 mbar on request

(2) Titanium available ≤ 400 bar (burst pressure > 550 bar)

(3) Process connection frontal and flush diaphragm available ≤ 600 bar

(4) Overpressure and burst pressure 1500 bar (stainless steel) optional

(5) Transducer

(6) Zero based accuracy according to DIN-16086, incl. hysteresis and repeatability at ambient temperature

(7) 1 year (typ. / max.), the long term stability can be improved by ageing (burn-in) the sensor

TEMPERATURE MEASURING RANGE

Standard, (1)	-25 ... 100 $^{\circ}$ C
Lower end of range	-40 $^{\circ}$ C
Upper end of range	150 $^{\circ}$ C
Temperature span, (2)	> 30 $^{\circ}$ C
Accuracy, (3)	
0...70 $^{\circ}$ C, (typ./max.)	$\pm 0.5 / 1.0$ $^{\circ}$ C
-25...85 $^{\circ}$ C, (typ./max.)	$\pm 1.0 / 1.5$ $^{\circ}$ C
-25...100 $^{\circ}$ C, (typ./max.)	± 2.0 $^{\circ}$ C

(1) Other temperature measuring ranges on request

(2) Measuring range 15 ... 30 $^{\circ}$ C must be contained

(3) Probe, electronics, calibration

TEMPERATURE RANGE

Operating temperature	-25 ... 85°C
Process temperature	-40 ... 150°C
Storage temperature	-25 ... 85°C

ELECTRICAL SPECIFICATIONS

	4 ... 20 mA	0 ... 20 mA	0 ... 5 V / 0 ... 10 V
Power supply	15 ... 30 VDC	15 ... 30 VDC	15 ... 30 VDC
Supply influence	< 0.1% FS	< 0.1% FS	< 0.1% FS
Current consumption			3 mA
Circuit diagram			
Load resistance	$(U_{\text{supply}} - 5V) / 0.02A$	$(U_{\text{supply}} - 5V) / 0.02A$	$R_L > 10 \text{ k}\Omega$
Load influence	< 0.1% FS	< 0.1% FS	< 0.1% FS

QUALIFICATIONS

	Description	Level	Typical interferences
EN 61000-4-2	Electrostatic discharge	4 kV contact / 8 kV air	
EN 61000-4-3	Irradiated RF	10V/m (0.08 ... 1 GHz, 3s)	Radio sets, wireless phones
EN 61000-4-4	Transients (burst)	2 kV	Motors, valves
EN 61000-4-6	Conducted RF	10 V (0.15 ... 80 MHz, 3 s)	Frequency converters

PHYSICAL SPECIFICATIONS

Materials	
Transducer	Stainless steel (316L / 1.4435), titanium (Gr. 2), (1)
Housing	Stainless steel (316L / 1.4404), titanium (Gr. 2)
Seals	Viton
Cable	PUR, FEP, PE

(1) Hastelloy (C-276) on request

Equipment

OVERVIEW

Accessories overview	
10.00.0091	Accessories overview
HART001	Cable Socket Connector DIN43650

Additional documents

OPERATING AND SAFETY INSTRUCTIONS

Article number	
10.88.0092	DMM029

Ordering information

	X	XXXX	XXXX	XX	XXX
Type					
	ATM/T	26			
Pressure type					
	Gauge	1			
	Absolute (vacuum)	2			
	Sealed gauge	3			
Pressure measuring range					
	50 mbar ... < 100 mbar		XX		
	100 mbar ... 600 bar		XX		
	> 600 bar		XX		
	Negative ranges, offset, special adjustment		99		
Process connection					
	G 1/2 M, frontal diaphragm, (Fig. 5), (4)		14		
	G 1/2 M, with flush diaphragm, (Fig. 6), (4)		15		
	Customized		99		
Electrical connection					
	DIN 43650 with metal threaded part, demountable, IP 65 (Fig. 10), (5)		01		
	M16 (Binder 723), 5-pin, IP 67 (Fig. 11), (5)		03		
	M16 (Binder 723), 5-pin, demountable, IP 67 (Fig. 12), (5)		43		
	MIL C26482, 10-6, IP 40 (Fig. 13), (5)		06		
	PE cable, IP 67, black (Fig. 14), (6), (7)		13		
	PUR cable, IP 67, black (Fig. 14), (6), (8)		15		
	FEP cable, IP 67, black (Fig. 14), (6)		21		
	Customized connection available		99		
Output signal					
	0 ... 5 V DC		46		
	0 ... 10 V DC		47		
	0 ... 20 mA		00		
	4 ... 20 mA		05		
	Customized		99		
Accuracy					
	$\leq \pm 0.5\%$ FS			0	
	$\leq \pm 0.25\%$ FS			1	
	$\leq \pm 0.1\%$ FS			2	
Temperature range					
	0 ... 70°C compensated process temperature: -25 ... 100°C	(allow		0	
	-25 ... 100°C compensated (allowed process temperature: -25 ... 100°C)			7	
	-25 ... 85°C compensated (allowed process temperature: -25 ... 100°C)			1	
	-25 ... 85°C compensated (allowed process temperature: -25 ... 150°C) with cooling fins			2	
	-25 ... 100°C compensated (allowed process temperature: -25 ... 150°C) with cooling fins			6	

	Customized		9
Option 1			
	Special oil filling: Anderol Food food applications)	(f	G
	Special oil filling: AS100 (suitable for process temperatures -55...150°C)		J
	Special oil filling: PA04 (silicone free)		Q
Option 2			
	Electronics packed in gel: Gauge pressure		D
	Titanium		K
	Seals: Viton (standard)		U
Option 3			

(4) Process connection available \leq 600 bar

(5) Cable socket connector not included

(6) Please specify the required cable length and medium

(7) Suitable for drinking water (food approved)

(8) For operating temperature $>$ 50°C, PE or FEP cable must be used

Technical drawings

Pressure Connections

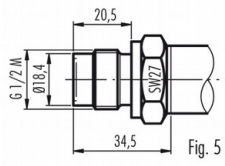

Fig. 5

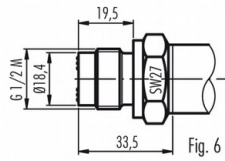
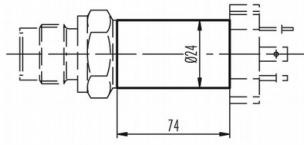

Fig. 6

Dimensions

Version for media temperature up to 100°C



Version for media temperature up to 150°C

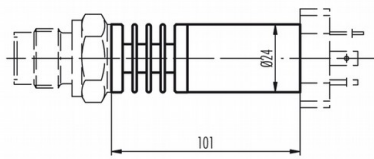

Electrical Connections

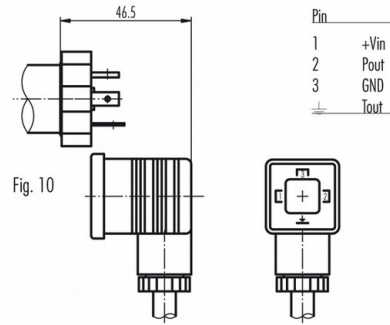

Fig. 10

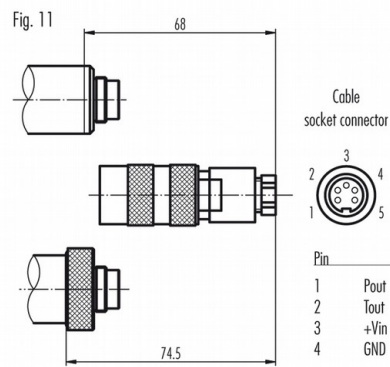

Fig. 11

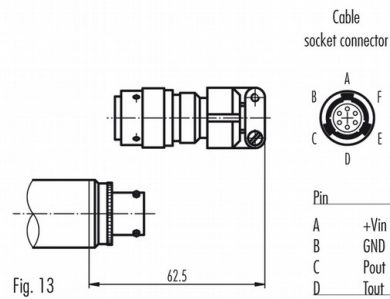

Fig. 13

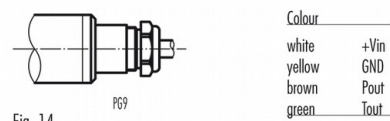

Fig. 14